



Allgemeine Daten / Global Properties	
Produktname Product name	Seilzug-Not-Halt-Schalter Emergency pull-wire switch
Typbezeichnung Type description	<i>siehe Typenschlüssel</i> <i>see ordering code</i>
Vorschriften Standards	DIN EN 60947-5-1, DIN EN 60947-5-5, DIN EN 620, DIN ISO 13850
EU-Richtlinien EC-Directives	Maschinenrichtlinie / Machinery Directive 2006/42/EG EMV-Richtlinie / EMC Directive 2014/30/EU RoHS-Richtlinien / RoHS Directives 2011/65/EU, 2017/2102/EU 
Zulassungen Approvals	UL/CSA (in Vorbereitung / in preparation) EAC (in Vorbereitung / in preparation) ATEX (in Vorbereitung / in preparation)

Sicherheitsbetrachtung / Safety assessment	
Sicherheitsfunktion Safety function	NOT-HALT, manuelle Rückstellung, Zwangsöffnung Emergency stop, manual reset, positive opening
Vorschriften Standards	DIN EN ISO 13849-1
B10d (NC)	100.000
Gebrauchsdauer Lifetime	10 Jahre 10 years
Einsatzbereich Application	Anlagen gemäß DIN EN 60204-1 Systems as per DIN EN 60204-1

Umgebungsbedingungen / Environmental conditions	
Umgebungstemperatur ambient temperature	-40°C...+70°C
Schutzart Protection type	IP 67 (DIN EN 60529)
Schutzklasse Protection class	I  (Typ A, Aluminiumgehäuse), II  (Typ D, Duroplastgehäuse) I (type A, housing aluminium), II (type D, housing duroplastic)
Einbaulage Installation position	beliebig (Sicherheits- und Installationsvorschriften beachten) any position (observe the safety regulations and installation instructions)
Verschmutzungsgrad	3

Typschlüssel /Type code

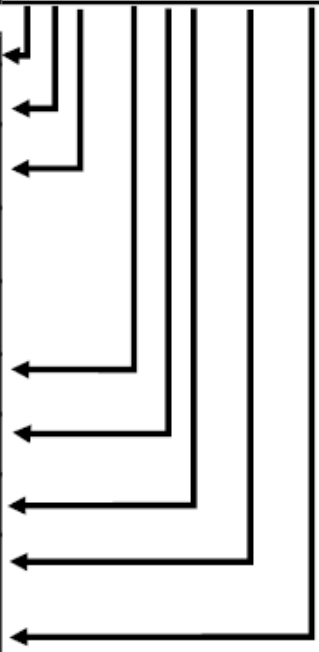
				SN A 2 - 1 1 S - V1 - L1
Gehäuse	Lieferumfang mit Kunststoffverschlusskappe	Seilzug-Not-Halt-Schalter	SN	
		Gehäuse Aluminium	A	
		Gehäuse Kunststoff	D	
		Kabeleinführung (Standard 2 Öffnungen M 25)	2	
		Kabeleinführung (2 Öffnungen M 20)	3	
Kabeleinführung (4 Öffnungen M 20)	4			
Schalteinheit		Anzahl Schließer (NO)	1,2 oder 3	
		Anzahl Öffner (NC)	1,2 oder 3	
		Kontakte silber	S	
		Kontakte vergoldet	G	
Deckel	Ventilationsmembrane	Ventilationsmembrane Messing	V1	
		Ventilationsmembrane Kunststoff	V2	
Lampe		Lampe LED 230V AC	L1	
		Lampe LED 24V AC/DC	L2	

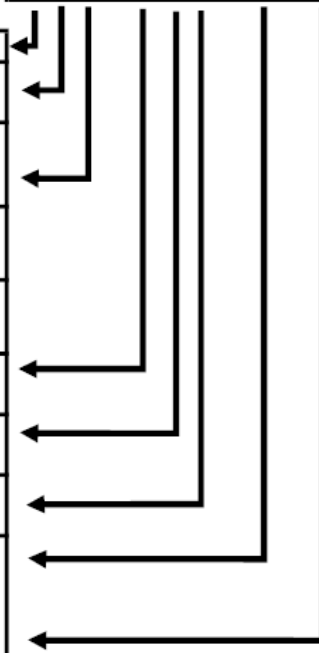
				SN A 2 - 1 1 S - V1 - L1
housing	including sealing caps	Pull Wire Emergency Stop Switch	SN	
		housing aluminum	A	
		housing high-grade plastic	D	
		cable entry points (standard 2 openings M 25)	2	
		cable entry points (2 openings M 20)	3	
cable entry points (4 openings M 20)	4			
switching unit		quantity closing contacts (NO)	1,2 or 3	
		quantity opening contacts (NC)	1,2 or 3	
		silver contacts	S	
		gold plated contacts	G	
cover	ventilation membrane	ventilation membrane brass	V1	
		ventilation membrane plastic	V2	
signal lamp		signal lamp LED 230V AC	L1	
		signal lamp LED 24V AC/DC	L2	

Mechanische Daten / Mechanical data	
Gehäusewerkstoff Material of the housing	Aluminium pulverbeschichtet (Typ A) / Duroplast (Typ D) Aluminium powder coated (Type A) / Duroplast (Type D)
Ausführung elektr. Anschluss Design of electrical connection	Schraubanschluss Screw connection
Anschlussquerschnitt cable section	1mm ² ...2,5mm ²
Mechanische Lebensdauer Mechanical lifetime	>10.000.000 Schaltspiele >10.000.000 operations
Betätigungskraft Actuating force	30N ±10N
Winkel bei Zwangsöffnungsweg Angle at positive opening	15°
max. Seillänge Max. length of wire	2 x 50m

Elektrische Daten / Electrical data	
Schaltelement Ausführung Design of control element	min. 1, max. 3 Schließer / min. 1, max. 3 Öffner (zwangsöffnend) min. 1, max. 3 normally open contact (NO) / min. 1, max. 3 normally closed contact (NC, positive opening)
Schaltprinzip Switching principle	Sprungschaltung Snap action
Bemessungsisolationsspannung U _i Rated insulation voltage U _i	400V
Bemessungsstoßspannung U _{imp} Rated insulation withstand voltage U _{imp}	2500V (Überspannungskategorie II)
Thermischer Dauerstrom I _{th} Thermal test current I _{th}	10A
Gebrauchskategorie Utilisation category	AC-15: 230V / 6A DC-13: 110V / 1,1A
Kurzschlusschutz Fuse rating	6A gG D-Sicherung 6A gG D-fuse
Signallampe (optional) Signal lamp (optional)	230VAC (L1): 23mA / 80mcd 24VAC/DC (L2): 15mA / 80mcd

Abmessungen / Dimensions

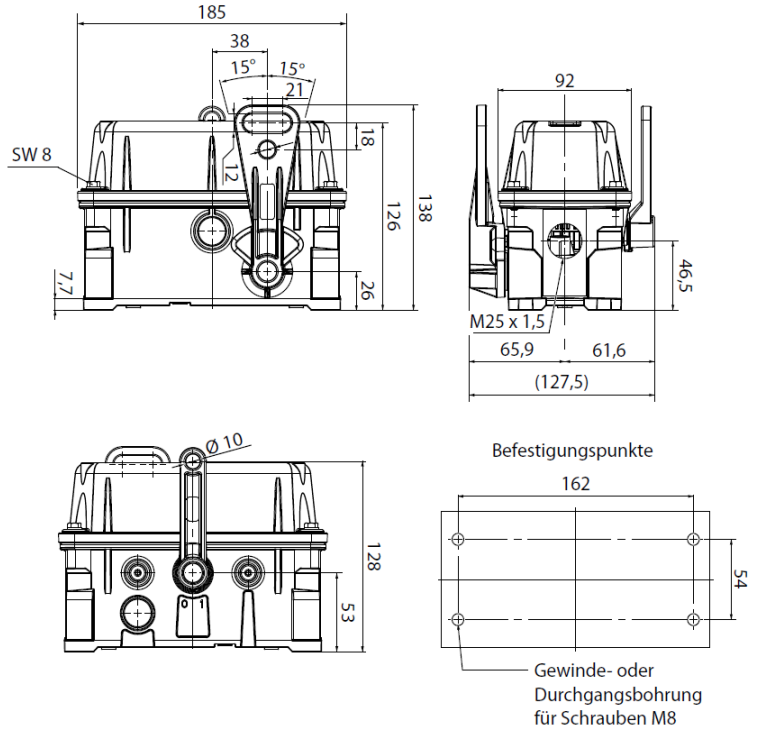

Gewicht
Weight

1,7 kg (Aluminium) / 1,5 kg (Duroplast)

Hinweis / Notice

Verdrahtungsbeispiel Lampe /
wiring example lamp

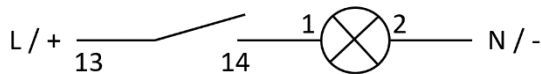

Bei Auslösen des NOT-HALT-BEFEHLS leuchtet die Lampe rot.

In case of triggering the emergency-stop-command the lamp will illuminate Red.

Steckerbelegung (Steckervariante auf Anfrage) /
Pin assignment (Plug variant on request)

	13 — 14	Stecker M23 (Gerät)
	33 — 34	Phoenix CA-09P1N126Y00
	21 — 22	Gegenstecker M23
	41 — 42	Standard- und SPEEDCON-Verriegelung (z.B. Phoenix CA-09S1N1280DN)
1	13	
2	33	
3	21	
4	41	
5	14	
6	34	
7	22	
8	42	
9	PE	

EFD Elektrotechnische Fabrik Düsseldorf GmbH

www.sitec-components.com

Eichsfelder Str. 17
40595 Düsseldorf
Deutschland / Germany

Ort und Datum der Ausstellung
Place and date of issue

Düsseldorf, 26. August 2019